

WLP-7920 15H Series

User's Manual

P/N: 205G00WLP79202, Version V1.0

Copyright © 2011, ALL RIGHTS RESERVED.

*All other brand names are registered trademarks of their
respective owner*

*Copyright Notice
Copyright © 2013
All Rights Reserved.
Printed in Taiwan.*

The information contained in this document is subject to change without any notices.

Acknowledgments

Greeting & Setup

Thank you for purchasing the WLP-7920-15H Panel PC. We wish that this unit will be durable and reliable in providing your needs. Please follow the instructions below to ensure the unit continues to have high performance

Unpacking

After opening the carton, there will be a unit with an accessory box. Examine the contents to see if there are damages to the unit and if all accessories are present.

Setting up

Please read this manual carefully and remember to keep this manual for future reference.

Safety Instructions & Cleaning

The unit has undergone various tests in order to comply with safety standards. Inappropriate use may be dangerous. Please remember to follow the instructions below to insure your safety during the installation and operating process.

Transporting & Placement of unit

- 1. When moving the unit on a cart; be very cautious. Quick stops, excessive forces and uneven surfaces may cause the cart to overturn thus risking the unit to fall to the ground.*
- 2. If the Monitor display unit does fall to the ground, immediately turn the power off and disconnect cords. Then contact a service technician for repairs. Continual use of the unit may result cause a fire or electric shock. Also, do not repair the unit on your own.*
- 2. Having two or more people transporting the display unit is recommended. In addition, when installing the open frame by suspending it also requires two or more people.*
- 3. Before suspending the unit, make sure the material used for suspension is sturdy and stable. If not properly suspended, the display unit may fall and cause serious injury to people standing nearby as well as to the unit itself.*
- 4. If you wish to mount the display unit, remember to use only the mounting hardware recommended by the manufacturer.*

Electrical and Power Source Related

- 1. This Monitor display unit must operate on a power source as shown on the specification label. If you are not sure what type of power supply used in the area, consult your dealer or local power supplier.*
- 2. The power cords must not be damaged. Applied pressure, added heat, and tugging may damage the power cord.*
- 3. The power cord must be routed properly when setup takes place. We advise that this aspect measure is to prevent people from stepping on the cords or while the unit is suspended to prevent flying objects from getting tangled with the unit.*
- 4. Do not overload the AC outlets or extension cords. Electrical shocks or fires may occur from overloading.*
- 5. Do not touch the power source during a thunderstorm.*
- 6. If your hands are wet, do not touch the plug.*
- 7. Use your thumb and index finger, grip firmly on the power cord to disconnect from the electrical socket. By pulling the power cord, may result in damaging it.*
- 8. If the unit is not going to be in use for an extended period of time, remember to disconnect the unit.*

-
9. *Connect the unit to a power source with the same numerical value as spec. label shown. Please use only the power cord provided by the dealer to ensure safety and EMC compliance.*

Various Factors of Environment

1. *Do not insert objects into the openings.*
2. *Do not have liquids seep into the internal areas of the Monitor display unit.*
3. *Having liquids seep in or inserting objects into the unit may result in electric shocks from taking and/or short circuiting the internal parts.*
4. *Do not place the Monitor display unit in the presence of high moisture areas.*
5. *Do not install the Monitor display unit in a wet environment.*
6. *Do not place near unit near heat generating sources.*
7. *Do not place the unit in a location where it will come in contact with fumes or steam.*
8. *Remember to keep the Monitor display unit away from the presence of dust.*
9. *If water has flow in or seep in, immediately disconnect the open frame unit. Then contact a service technician for repairs.*

Ventilation Spacing

1. *Do not cover or block the openings on the top and back sides of the display unit. Inadequate ventilation may cause overheating thus reducing the lifespan of the unit.*
2. *Unless proper ventilation is present, do not place unit in an*

enclosed area; such as a built-in shelf. Keep a minimum distance of 10 cm between the display unit and wall.

Cleaning the unit

- (1) Remember to turn off the power source and to unplug the cord from the outlet before cleaning the unit.*
- (2) Carefully dismount the unit or bring the unit down from suspension to clean.*
- (3) Use only a dry soft cloth or clean room wiper when cleaning the LCD panel or touch screen surface. Use a soft cloth moistened with mild detergent to clean the display housing.*
- (4) Remember to avoid having liquids seep into the internal components.*

Servicing, Repairing, Maintenance & Safety Checks

- 1. If the unit is not functioning properly, observe the performance level of the display closely to determine what type of servicing is needed.*
- 2. Do not attempt to repair the Monitor display unit on your own. Disassembling the cover exposes users' to high voltages and other dangerous conditions. Notify and request a qualified service technician for servicing the unit.*
- 3. If any of the following situations occur turn the power source off and unplug the unit. Then contact a qualified service technician*
 - (a) A liquid was spilled on the unit or objects have fallen into the unit.*
 - (b) The unit is soaked with liquids.*
 - (c) The unit is dropped or damaged.*

-
- (d) If smoke or strange odor is flowing out of the open frame unit.*
 - (e) If the power cord or plug is damaged.*
 - (f) When the functions of the unit are dysfunctional.*
- 4. When part replacement is needed. Make sure service technician uses replacement parts specified by the manufacturer, or those with the same characteristics and performance as the original parts. If unauthorized parts are used it may result in starting a fire, electrical shock and/or other dangers.*

Battery Installation

Follow below instructions and notice the caution for replacing and disposing of the RTC Lithium battery CR2032 for safety consideration.

CAUTION:

There is danger of explosion, if battery is incorrectly replaced. Replace only with the same or equivalent type recommended by the manufacturer. Dispose of used batteries according to the manufacturer's instruction.

The specification is subject to change without notice.

Version Change History

Date	Version	Description	Remark
2013/7/5	V1.0	First release	Cosa

Table of Contents

<i>How to Use This Manual</i>	X
System Overview	1
<i>System View</i>	5
<i>I/O connectors</i>	6
<i>VESA mount installation</i>	6
<i>Panel mount installation</i>	8
<i>Unpacking</i>	9
Getting Started	10
<i>Setting up the System</i>	10
<i>Installing the Drivers</i>	13
BIOS Setup Information	14
Appendix	26
B. Wake UP on LAN Function	45

How to Use This Manual

This manual is written for the system integrator, PC technician and knowledgeable PC end user. It describes how to configure your WLP-7920-15H Panel PC to meet various operating requirements. The user's manual is divided into three chapters, with each chapter addressing a basic concept and operation of the server board.

Chapter 1: System Overview - presents what you have inside the box and gives you an overview of the product specifications and basic system architecture for the WLP-7920-15H Panel PC.

Chapter 2: System Installation - describes how to set up the system.

Chapter 3: BIOS Setup Information - specifies the meaning of each setup parameter, how to get advanced BIOS performance and update to a new BIOS. Additionally, the POST checkpoint list will give you a guide for troubleshooting.

The contents of this manual are subject to change without prior notice. These changes will be incorporated in new editions of this manual.

System Overview

System Specification

<i>CPU</i>	<i>Atom D525 1.8G</i>
<i>FSB</i>	<i>800MHz</i>
<i>Chipset</i>	<i>South bridge: Intel® ICH8M</i>
<i>Audio</i>	<i>Realtek ALC268 Audio Codec, 2+2 watts power amplifier</i>
<i>LAN</i>	<i>Marvell 88E8071 Gigabit Ethernet x 1</i>
<i>Memory</i>	<i>Single Channel, two DDR3 SODIMM socket support up to 4GB</i>
<i>I/O</i>	<i>Intel® ICH8M</i>
<i>Serial ATA</i>	<i>SATA II controller (3.0Gb/sec) Port x 2</i>
<i>Serial port</i>	<i>RS232/422/485 x 1, RS232 x 1 (one at I/O bottom, one with internal pin head)</i>
<i>USB</i>	<i>External USB 2.0 type A x 3</i> <i>Internal For touch screen x 1</i> <i>For WiFi (mini-PCIE) x 1</i> <i>Pin Head to expansion x 2</i>
<i>WDT</i>	<i>Generates system reset; 256 segments, 0, 1, 2...255 sec.</i>

RAM module installation

Please follow this form to install RAM

Capacity	Dimm 0	Dimm 1
1G	1G	
2G	1G	1G
2G	2G	
3G	2G	1G
4G	4G	
4G	2G	2G

BIOS

Brand: AMI

Flash ROM size: 16M

Support RTC wakeup /Wake on LAN /Power on after power failure/PnP/ACPI/RTC

Display**Panel**

<i>Brand</i>	<i>AGL</i>
<i>Model</i>	<i>VM15B3 V1</i>
<i>Resolution (pixel)</i>	<i>1024x768 XGA</i>
<i>Number of Colors</i>	<i>16.2 M colors</i>
<i>View Angle (H/V)</i>	<i>R/L 160(Typ.), U/D 150(Typ)</i>
<i>Brightness (cd/m2)</i>	<i>1000nit</i>
<i>Contrast Ratio</i>	<i>600:1</i>
<i>Backlight</i>	<i>LED</i>

LED backlight driver

KE-12LED-2L1933

Touch Screen: resistive or capacitive types

	AMT
Model name	AD-28115
Type	5 wire RES
Glove	Any type glove
Stylus	No Limitation, can use any stylus
Interface	USB
Light Transmission	80±3%
Glass thickness	1.8mm
Linearity	$X \leq 1.5\%$, $Y \leq 1.5\%$
Lifetime	36 million activations

Touch Controller

RES EETI ,IC8051F321,MCU,TOUCH,28P,0.5MM,SMT,QFN

CAP EETI,ETP-ESCAP7000-02 (Option)

Storage

HDD 2.5" SATA HDD drive bay x 1

SATA DOM 2nd SATA connector pin7 with VCC_(+5V)

Expansion

Mini-PCIe 52 pin card-edge type x 1 support half/full size (for WLAN module)

External I/O

USB USB 2.0 x 3

COM DB-9 x 3 (RS232/422/485 x 1, RS232 x 2)

LAN RJ-45 x 1 (Gigabit Ethernet)

Audio 3.5mm phone jack connector * 2 (Line-out, and Mic-in)

VGA output DB-15 x 1

Power

Power DC-In connector x 1

Switch Reset key

Mother board power Input *DC 12~28V*

Power Adapter *AC 100 ~ 240V / 47 ~ 63 Hz / DC output 12V*

System power input *DC 12V, others by optional DC-DC adapter*

Ambient light sensor detects ambient light for automated screen adjustments to optimize viewing.

Software utility for manually brightness control

LED status indicator

Right side: System power on: green, HDD accessing: orange

Left side: self-preheating on: red

Mechanical & Environmental

Material construction *Front bezel is Aluminum or SECC, others are SECC enclosure*

Aluminum bezel Color *Black/Silver*

Front Panel Protection *IP66*

ID design *Panel mount*

Operation Temperature *12V DC Input -20~65 °C
(IEC60068-2-56, air flow cooling)*

*12V DC Input -20~50 °C
(IEC60068-2-2, natural cooling)*

Storage Temperature *-30~70 °C*

Operation Relative Humidity *10%~90%, non-condensing*

Storage Relative Humidity *10%~90%, non-condensing*

Mounting *Panel mount/VESA (75x75)*

	Net Weight	Gross Weight
15"	6.6Kg	9.6Kg

	Panel mount
15"	398x330x58 mm

System View

WLP-7920-15H Outline Drawing (Panel Mount)

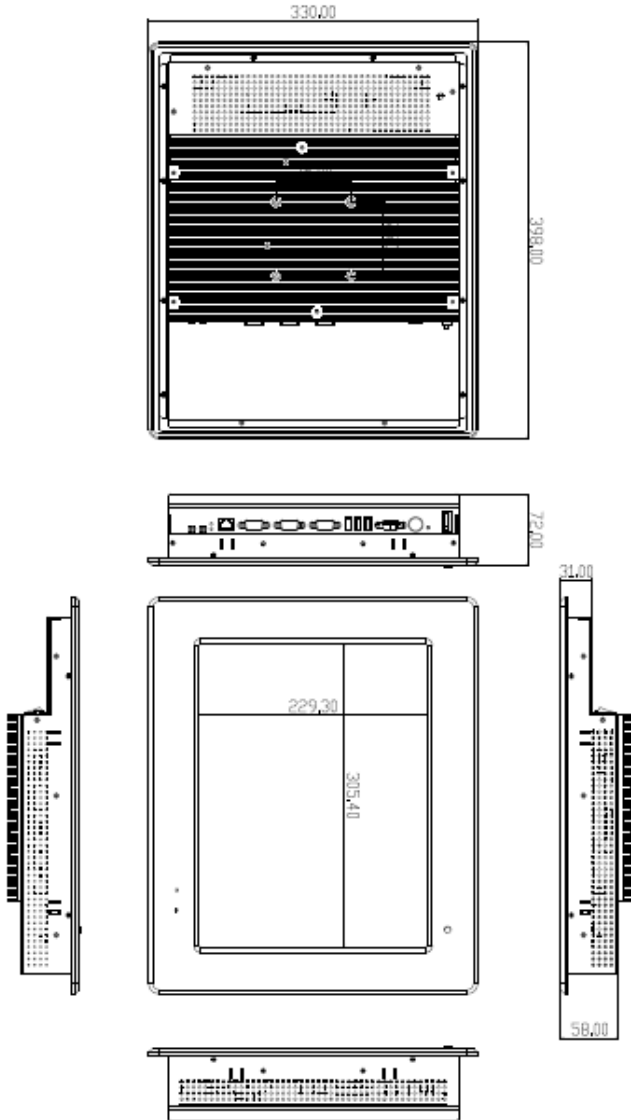

I/O connectors



Note: Share the same place with VGA output, DVI and VGA not simultaneously

VESA mount installation

Please use the supplied 4 x M4-L10 screws for VESA mounting. And as below VESA mounting holder is just a diagrammatic drawing. You can choose any standard VESA 75x75 mm mounting holder to mount our machine.

For use only with UL listed Wall Mount Bracket with minimum weight/load bearing capacity 10 Kg

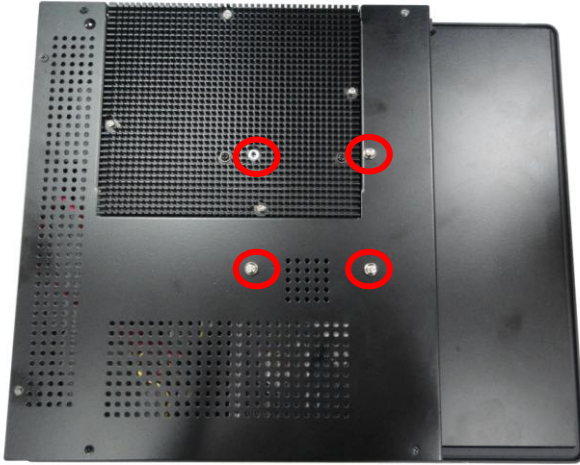

Panel mount installation

1. The Panel PC can be panel mounted and comes with brackets and screws for this purpose. The required cutout for panel mounting and maximum panel thickness is shown below.

	A	B	C
WLP-7920-15H	375	305	16

Unit: mm

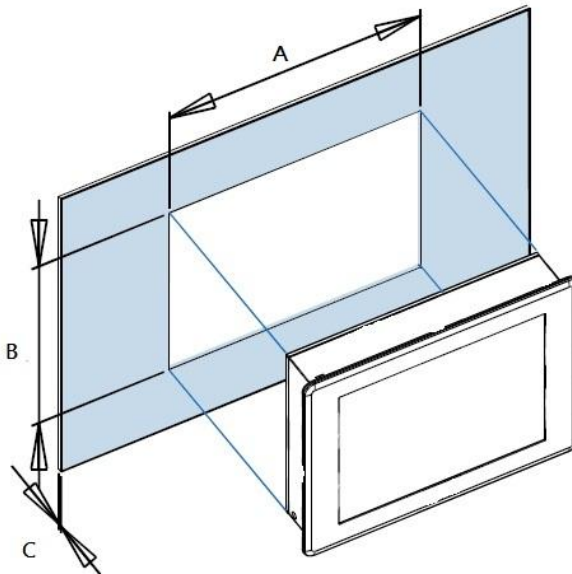

2. Secure the chassis to the panel by tightening the screws and brackets against the panel.



Unpacking

After unpacking the shipping carton, you should find these standard items:

- *The WLP-7920-15H Panel PC series*
- *Accessory box including the followings:*
 - *AC-DC adapter x 1*
 - *AC power cord x 1*
 - *Mounting brackets x4*
 - *Screws (M3x0.5PxL6) x 8*
 - *Screws (M4x0.7PxL44) x 8*
 - *CD-ROM for drivers, utility, user manual(in PDF format)*

Inspect all the items. If any item is damaged or missing, notify your dealer immediately.

Getting Started

This chapter tells you how to set up the system.

Setting up the System

The following is a summary of the steps in setting up the system for use.

CAUTION: Make sure that power to the system and each of the devices to be connected is switched OFF before plugging in the connectors.

- 1. Make any required external connections such as the keyboard, and mouse.*
- 2. Plug the appropriate end of the power cord into the power connector of the system. Then plug the other end of the power cord to an electrical outlet.*
- 3. Press the power switch of the system to turn on the system's power.*
- 4. If necessary, run the BIOS SETUP program to configure the system (see Chapter 3).*
- 5. Install the software drivers if necessary.*

Installing System Software

Recent releases of operating systems from major vendors include setup programs, which load automatically and guide you through hard disk preparation and operating system installation. The guidelines below will help you determine the steps necessary to install your operating system on the Panel PC hard drive.

NOTE: *Some distributors and system integrators may have already pre-installed system software prior to shipment of your Panel PC.*

Installing software requires an installed HDD. Software can be loaded in the WLP-7920-15H Panel PC using any of below methods:

Method 1: Use the Ethernet

You can use the Ethernet port to download software from the net to the HDD that has been pre-installed in WLP-7920-15H Panel PC

Method 2: Use the COM Port

By connecting another PC to the WLP-7920-15H Panel PC with an appropriate cable, you can use transmission software to transmit Operation System Software to the HDD that has been pre-installed in the WLP-7920-15H Panel PC.

Method 3: Use a External CD-ROM

In order to boot up system from USB-CD/DVD drive, please connect USB-CD/DVD drive, turn on computer power, keep on pressing "F11" key, go into BIOS quick boot menu, select "USB-CD ROM", WAIT FOR 20 SECONDS, then press enter, system OS will boot up from USB-CD/DVD drive directly

Then you can use the external CD-ROM to transmit the software to the HDD that has been pre-installed in the WLP-7920-15H Panel PC

Installing the Drivers

After installing your system software, you will be able to set up the LAN, VGA, Audio and USB functions. All drivers are stored in a CD disc, which can be found in your accessory pack.

The various drivers and utilities in the disc have their own text files that help users install the drivers and understand their functions.

Note:

eGalax Touch driver supports both resistive and capacitive touch screens, user can find 2 touch icons shown in utility, please set up touch screen by selecting the correlative one.

(USB controller: resistive touch screen, USB controller: capacitive touch screen)

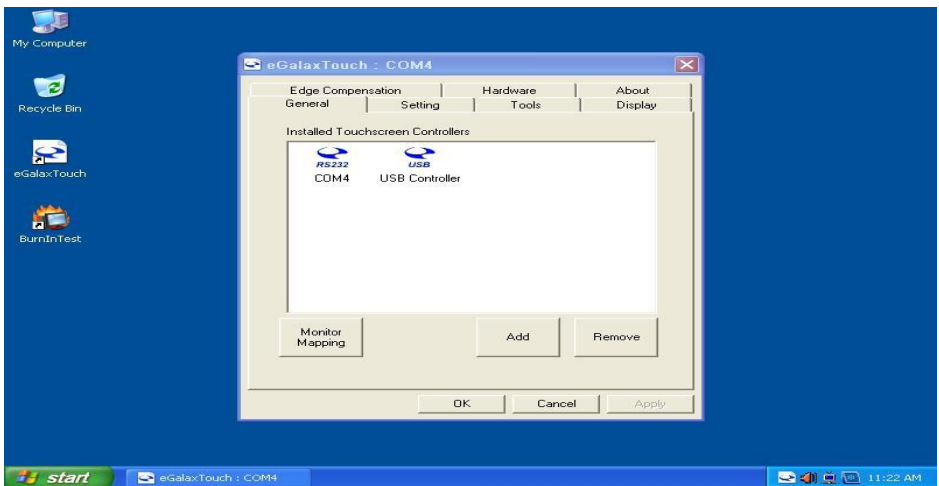

BIOS Setup Information

BIOS Introduction

The AMI BIOS (Basic Input/Output System) installed in your computer system's ROM supports Intel processors. The BIOS provides critical low-level support for a standard device such as disk drives, serial ports and parallel ports. It also adds virus and password protection as well as special support for detailed fine-tuning of the chipset controlling the entire system.

WLP-7920-15H BIOS Setup

The AMI BIOS provides a Setup utility program for specifying the system configurations and settings. The BIOS ROM of the system stores the Setup utility. When you turn on the computer, the Award BIOS is immediately activated. Pressing the key immediately allows you to enter the Setup utility. If you are a little bit late pressing the key, POST (Power On Self Test) will continue with its test routines, thus preventing you from invoking the Setup. If you still wish to enter Setup, restart the system by pressing the "Reset" button or simultaneously pressing the <Ctrl>, <Alt> and <Delete> keys. You can also restart by turning the system Off and back On again. The following message will appear on the screen:

Press to Enter Setup

In general, you press the arrow keys to highlight items, <Enter> to select, the <PgUp> and <PgDn> keys to change entries, <F1>

for help and <Esc> to quit.

When you enter the Setup utility, the Main Menu screen will appear on the screen. The Main Menu allows you to select from various setup functions and exit choices.

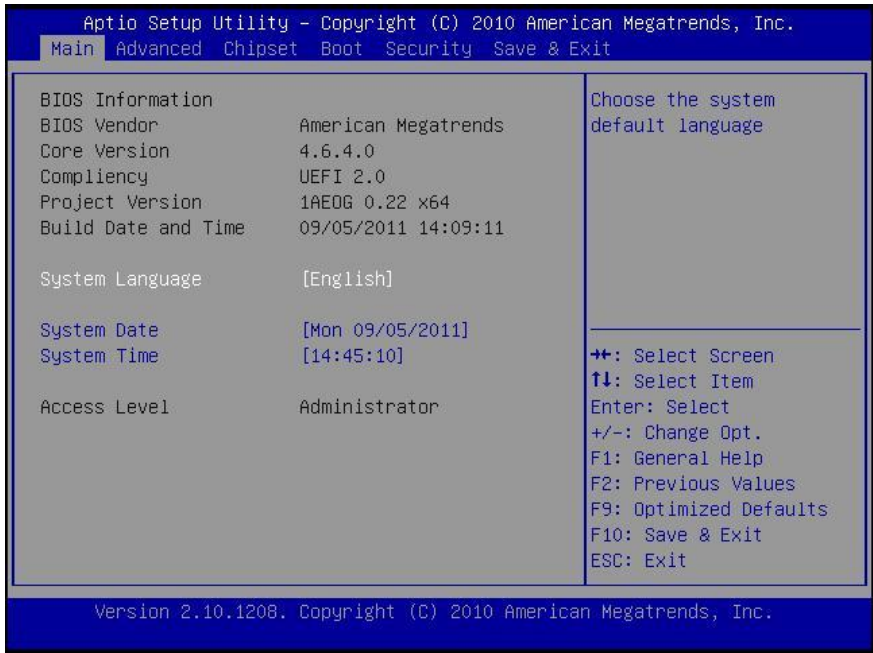

This section provides information on the BIOS information, Memory information, and LAN MAC information

System Language

Choose the BIOS default language.

System Date/Time

Sets the system date/time. Use the <Tab> key to switch between data/time elements.

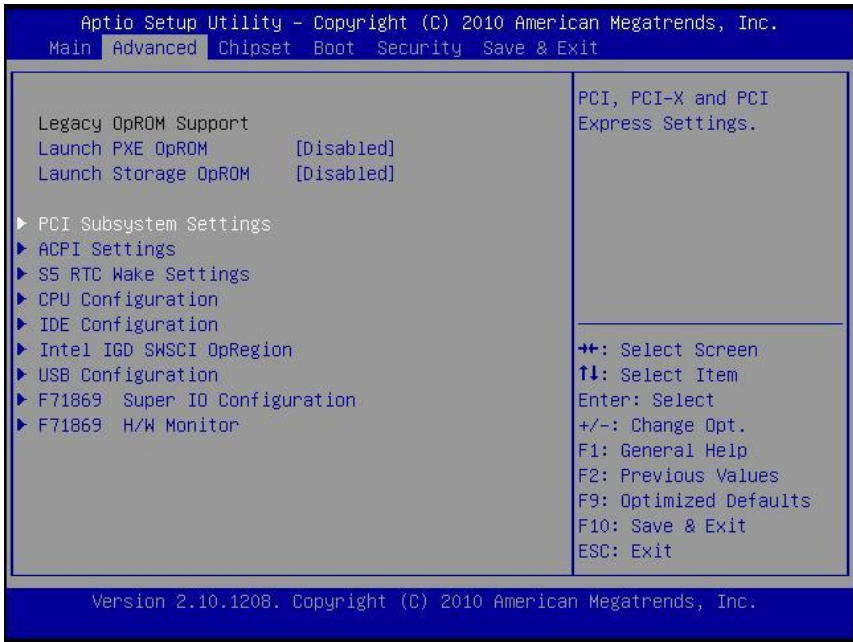

Launch OpROM Support

Launch PXE OpROM

Enables or disables Boot Option for Legacy Network Devices.

Launch Storage OpROM

Enables or disables Boot Option for Legacy Mass Storage Devices with Option ROM.

PCI Subsystem Settings

PCI ROM Priority

In Case of multiple Option ROMs (Legacy and EFI Compatible), specifies what PCI Option ROM to launch.

PCI Latency Timer

Value to be programmed into PCI Latency Timer Register.

VGA Palette Snoop

Enables or disables VGA Palette Registers Snooping.

PERR# Generation

Enables or Disables PCI Device to Generate PERR#.

SERR# Generation

Enables or Disables PCI Device to Generate SERR#.

Relaxed Ordering

Enables or Disables PCI Express Device Relaxed Ordering.

Extended Tag

If ENABLED allows Device to use 8-bit Tag field as a requester.

No Snoop

Enables or Disables PCI Express Device No Snoop option.

Maximum Payload

Set Maximum Payload of PCI Express Device or allow System BIOS to select the value

Maximum Read Request

Set Maximum Read Request Size of PCI Express Device or allow System BIOS to select the value.

ASPM Support

Set the ASPM Level: Force L0 – Force all links to L0 State :
AUTO – BIOS auto configure : DISABLE – Disables ASPM.

Extended Synchron

If ENABLED allows generation of Extended Synchronization patterns.

ACPI Settings

Enables ACPI Auto Conf

Enables or Disables BIOS ACPI Auto Configuration.

Enable Hibernation

Enables or Disables System ability to Hibernate (OS/S4 Sleep State). This option may be not effective with some OS.

ACPI Sleep State

Select the highest ACPI sleep state the system will enter, when the SUSPEND button is pressed.

S5 RTC Wake Settings

Wake System with Fixed Time

Enables or disables system wake on alarm event. When enabled, the system will wake on the time specified.

Wake system with Dynamic Time

Enables or disables system wake on alarm event. When enabled, the system will wake on the current time+Increase minute(s).

CPU Configuration

Hyper-Threading

Enabled for Windows XP and Linux (OS optimized for Hyper-Threading Technology) and Disabled for other OS (OS optimized for Hyper-Threading Technology)

Core-Multi Processing

Enable or Disable Core-Multi Processing mode.

Execute Disable Bit

XD can prevent certain classes of malicious buffer overflow attacks when combined with a supporting OS (Windows Server 2003 SP1, Windows XP SP2, SuSE Linux 9.2, RedHat Enterprise 3 Update 3.)

Limit CPUID Maximum

Disabled for Windows XP.

IDE Configuration

ATA or IDE Configuration

Select ATA or IDE configuration.

Configure SATA AS

Select a configuration for SATA controller.

HDD Acoustic Power Ma

Option to enable or disable HDD Acoustic Power Management.

DiPM

Option to enable or disable DiPM

Intel IGD SWSCI OpRegion

DVMT Mode Select

Selects DVMT Mode used by Internal Graphics Device.

DVMT/FIXED Memory

Selects DVMT/FIXED Mode Memory size used by Internal Graphics Device.

IGD – Boot Type

Select the Video Device which will be activated during POST. This has no effect if external graphics present.

LCD Panel Type

Select LCD panel used by Internal Graphics Device by selecting the appropriate setup item.

Panel Scaling

Select the LCD panel scaling option used by the Internal Graphics Device.

GMCH BLC Control

Back Light Control Setting

BIA Control

Spread Spectrum clock

>>Hardware: Spread is controlled by chip;

>>Software: Spread is controlled by BIOS.

TV1 Standard

TV2 Standard

Active LFP

Select the Active LFP Configuration.

No LVDS:VBIOS does not enable LVDS.

INT-LVDS:VBIOS enables LVDS driver by
Integrated encoder.

SDV0 LVDS:VBIOS enables LVDS driver by SDV0.

USB Configuration

Legacy USB Support

Allows USB devices to be used in MS-DOS.

EHCI Hand-off

This is a workaround for OSes without EHCI hand-off support.
The EHCI ownership change should be claimed by EHCI
driver.

USB transfer time-out

The time-out value for Control, Bulk, and Interrupt
transfers.

Device reset time-out

USB mass storage device Start Unit command
time-out.

Device power-up delay

Maximum time the device will take before it properly
reports itself to the HOST Controller.

'Auto' uses default value: for a Root port it is 100
ms, for a Hub port the delay is taken from Hub
descriptor.

F71869 Super IO Configuration

Serial Port 0 Configuration

Set Parameters of Serial Port 0 (COMA).

Serial Port 1 Configuration

Set Parameters of Serial Port 1 (COMB).

F71869 H/W Monitor

Monitor hardware status

Second Super IO Configuration

Serial Port 1 Configuration

Set Parameters of Serial Port 1 (COMC).

Serial Port 2 Configuration

Set Parameters of Serial Port 2 (COMD).

Serial Port 3 Configuration

Set Parameters of Serial Port 3 (COME).

Serial Port 4 Configuration

Set Parameters of Serial Port 4 (COMF).

Serial Port Console Redirection

Serial Port Console Redirection.

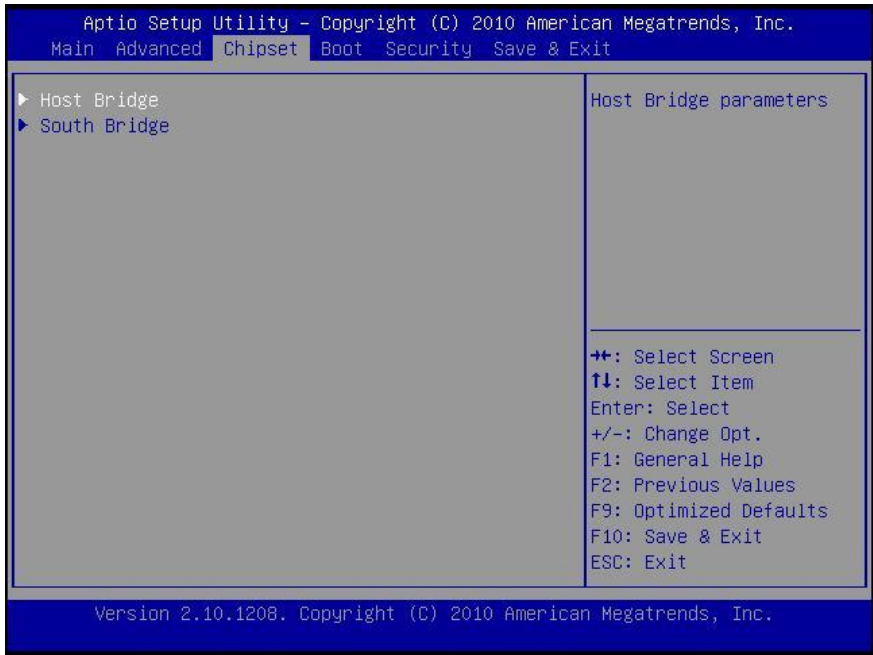

Host Bridge/South Bridge

This screen provides information on Host Bridge/South Bridge parameters.

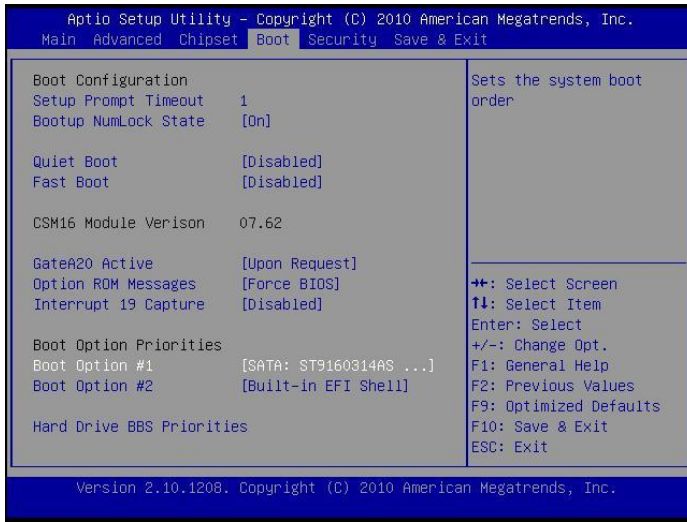

Setup Prompt Timeout

Number of seconds to wait for setup activation key. 65535(0xFFFF) means indefinite waiting.

Bootup Numlock State

Selects the keyboard NumLock state.

Full Screen LOGO Show

Allows you to determine whether to display the AMI Logo at system startup. **Disabled** displays normal POST message.

Fast Boot

Enables or disables the quick boot function to speed up the system boot-up process to shorten the waiting time for entering the operating system and to deliver greater efficiency for daily use.

GateA20 Active

This option is useful when any RT code is executed above 1MB. Upon Request GA20 can be disabled using BIOS services. (Default)

Always Do not allow disabling GA20.

Option ROM Messages

Sets display made for option ROM.

Interrupt 19 Capture

Enables or disables Option ROMs to Trap Int 19.

Boot Option Priorities

Specifies the sequence of loading the operating system from the installed hard drives.



Enables or disables the security chip. It is recommended that you use this function with the Administrator/User password.

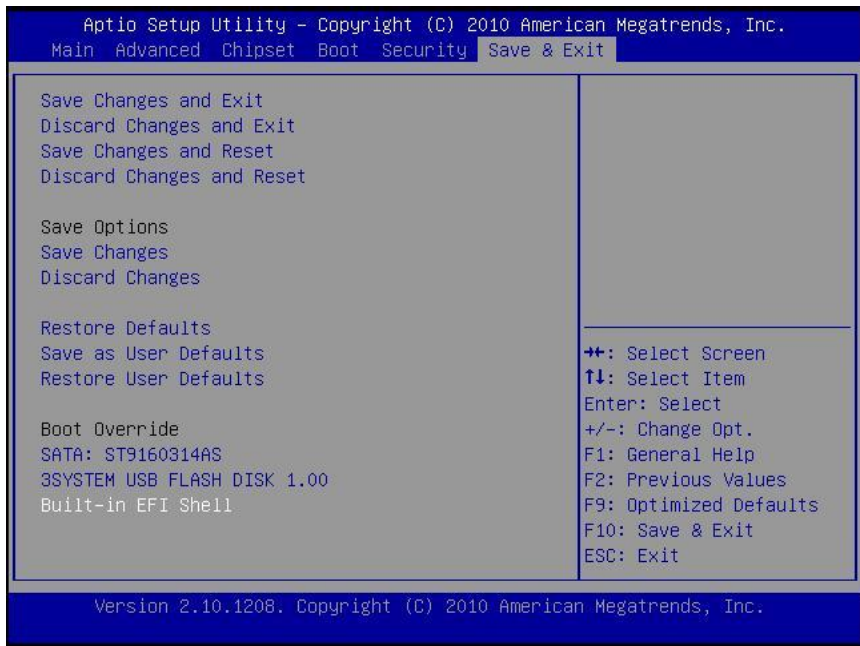

Save Changes and Exit

Exit system setup after saving the changes.

Discard Changes and Exit

Exit system setup without saving any changes.

Save Changes and Reset

Reset the system after saving the changes.

Discard Changes and Reset

Reset system setup without saving the changes.

Save Changes

Save the changes done so far to any of setup options.

Discard Changes

Discard the changes done so far to any of setup options.

Restore Defaults

Restore/load default values for all the setuo options.

Save as User Defaults

Save the changes done so far as User Defaults.

Restore User Defaults

Restore the User Defaults to all the setup options.

EFIGUI_FLASH

Press <Enter> to execute the simple EFI GUI Flash Program.

Appendix

A. Jumper settings and Connectors

This appendix gives the definitions and shows the positions of jumpers, headers and connectors. All of the configuration jumpers on WLP-7920-15H are in the proper position.

Note: Some of jumpers or connectors will be removed base on system configuration.

Jumper and Connector Definition Block Diagram

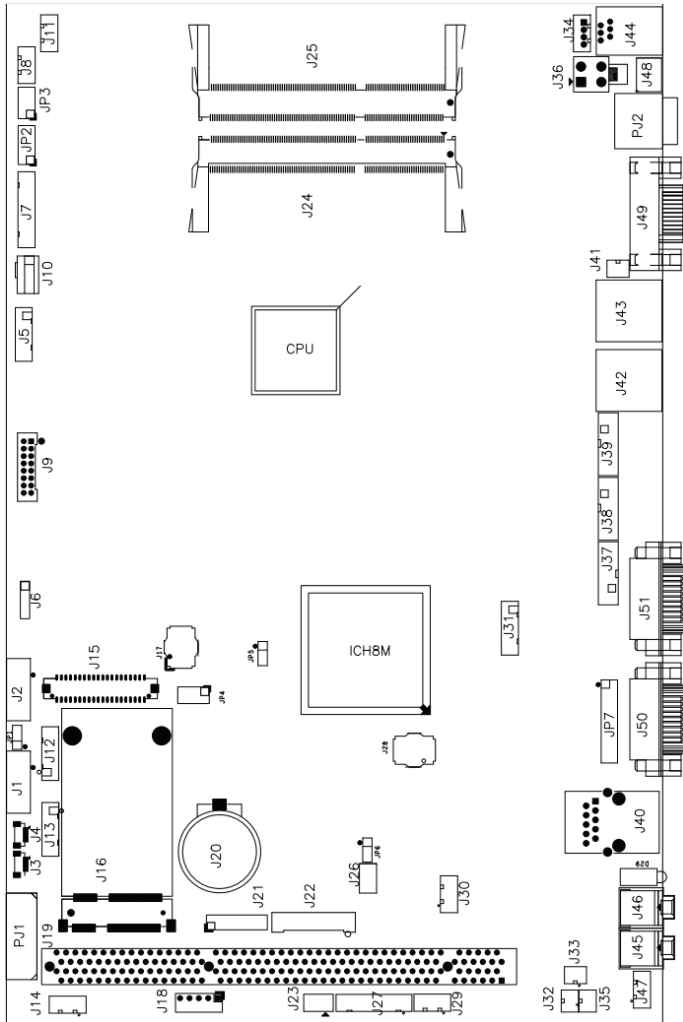

JP1 – SATA DOM Selection

Description	Jumper Setting
SATA DOM	1-2
SATA	2-3(<i>default</i>)

JP2 – Touch Panel Wire Selection

Description	Jumper Setting
4 wire	1-2, 3-4, 5-6, 7-8, 9-10
5 wire	3-4, 5-6, 7-8, 9-10(<i>default</i>)
8 wire	1-2

JP3 – Touch Panel Type Selection

Description	Jumper Setting
3M type	1-2, 3-4(<i>default</i>)
ELO type	5-6,7-8

JP4 – Panel Power Selection

Description	Jumper Setting
5VS (<i>for 17"/19"</i>)	1-2,3-4(<i>default</i>)
3.3VS (<i>for 10"/12"/15"</i>)	5-6,7-8

JP5 – CMOS Clear

Description	Jumper Setting
<i>Normal</i>	1-2(<i>default</i>)
CMOS Clear	2-3

JP6 – Thermal Detection Mode

Description	Jumper Setting
<i>Auto</i>	1-2(<i>default</i>)
Force 25°C	2-3
Force < -40°C	NC

JP7 – COM1 Function Selection

Description	Jumper Setting
RS-232	5-6, 9-11, 10-12, 15-17, 16-18(<i>default</i>)
RS-422	3-4, 7-9, 8-10, 13-15, 14-16, 21-22
RS-485	1-2, 7-9, 8-10, 19-20

JP8 – Resolution Mode

Description	Jumper Setting
-------------	----------------

1ch18bit-->2ch24bit(scaler) 1-2
 1ch18bit-->1ch24bitx2(bypass) 3-4
 1ch18bit-->1ch18bitX2(bypass) 5-6
1ch18bit-->2ch24bit(bypass)** NC(default)

** bypass for VBIOS resolution

Connector Definition

PJ1 – HDD Power Connector

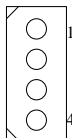

Pin #	Signal Description
1	+12V
2	Ground
3	Ground
4	+5V

PJ2 – Power Jack Connector

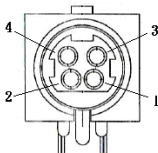

Pin #	Signal Description
1	DC In (+12V~+28V)
2	DC In (+12V~+28V)
3	Ground
4	Ground
5	Ground

J1, J2 – Standard SATA Interface

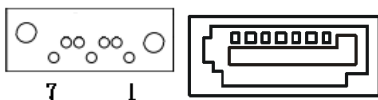

Pin #	Signal Description
-------	--------------------

-
- 1 Ground
 - 2 Tx+
 - 3 Tx-
 - 4 Ground
 - 5 Rx-
 - 6 Rx+
 - 7 Ground

J3,J4 – Internal USB 3.3V(internal)

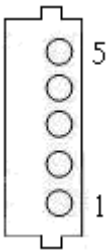

Pin #	Signal Description
-------	--------------------

- | | |
|---|--------|
| 1 | +3.3V |
| 2 | Data - |
| 3 | Data + |
| 4 | Ground |
| 5 | Ground |

J5 – LCD Inverter Interface

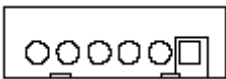

Pin #	Signal Description
-------	--------------------

- | | |
|---|------------------|
| 1 | +12V |
| 2 | +12V |
| 3 | Backlight Adjust |
| 4 | Backlight Enable |
| 5 | Ground |
| 6 | Ground |

J7 –Touch Panel Interface

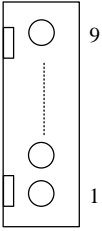

Pin #	Signal Description		
	8-wire	4-wire	5-wire
1	UL(X+)	UL(X+)	UL(X+)
2	UR(Y+)	UR(Y+)	UR(Y+)
3	N/A	N/A	PRCBE
4	LR(X-)	LR(X-)	LR(X-)
5	LL(Y-)	LL(Y-)	LL(Y-)
6	X+_DRIVE	N/A	N/A
7	Y+_DRIVE	N/A	N/A
8	X-_DRIVE	N/A	N/A
9	Y-_DRIVE	N/A	N/A

J8,J10,J14 – AUX, CPU, SYSTEM PWM FAN

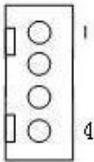

Pin #	Signal Description		
	J8(AUX)	J10(CPU)	J14 (SYSTEM)
1	AUX PWM	CPU PWM	SYS PWM
2	AUX RPM	CPU RPM	SYS RPM
3	VAUXFAN	VCPUXFAN	VSYSXFAN
4	GND	GND	GND

J12, J13 – Internal USB 5V(internal)

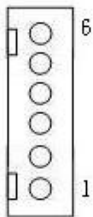

Pin #	Signal Description
1	+5V
2	+5V
3	Data -
4	Data +
5	Ground
6	Ground

J15 – LVDS Interface

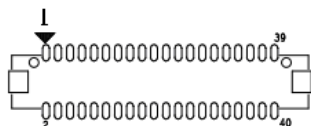

Pin #	Signal Description	Pin #	Signal Description
1	+LCD (+5V)	2	+LCD (+5V)
3	+LCD (+5V)	4	+LCD (+5V)
5	Ground	6	Ground
7	Ground	8	Ground
9	A_RxIn0-	10	B_RxIn0-
11	A_RxIn0+	12	B_RxIn0+
13	Ground	14	Ground
15	A_RxIn1-	16	B_RxIn1-
17	A_RxIn1+	18	B_RxIn1+
19	Ground	20	Ground
21	A_RxIn2-	22	B_RxIn2-
23	A_RxIn2+	24	B_RxIn2+
25	Ground	26	Ground
27	A_CKIN-	28	B_CKIN-
29	A_CKIN+	30	B_CKIN+
31	Ground	32	Ground
33	A_RxIn3-	34	B_RxIn3-

35	A_RxIn3+	36	B_RxIn3+
37	Ground	38	Ground
39	Ground	40	Ground

J16 – mini PCI Express Socket

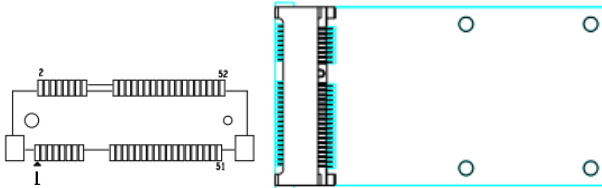

Pin #	Signal Description	Pin #	Signal Description
1	PCIE_WAKE#	2	+3.3V
3	NC	4	GND
5	NC	6	+1.5V
7	NC	8	NC
9	GND	10	NC
11	CLK_MINI_PCIE_N	12	NC
13	CLK_MINI_PCIE_P	14	NC
15	GND	16	NC
17	NC	18	GND
19	NC	20	NC
21	GND	22	PLT_RST#
23	PCIE_RXN6	24	+3.3V
25	PCIE_RXP6	26	GND
27	GND	28	+1.5V
29	GND	30	SMB_CLK
31	PCIE_TXN6	32	SMB_DATA
33	PCIE_TXP6	34	GND
35	GND	36	USBPN4
37	GND	38	USBPP4
39	+3.3V	40	GND
41	+3.3V	42	NC
43	GND	44	NC
45	NC	46	NC
47	NC	48	+1.5V
49	NC	50	GND
51	NC	52	+3.3V
53	NC	54	NC

J18 – JTAG

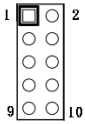

Pin #	Signal Description	Pin #	Signal Description
1	+3.3V	2	GND
3	GND	4	C8051 DATA
5	+3.3V	6	NC
7	C8051 RESET	8	NC
9	GND	10	NC

J19 – Standard PCI-X Slot Interface(Support PCI & PCIeX4)

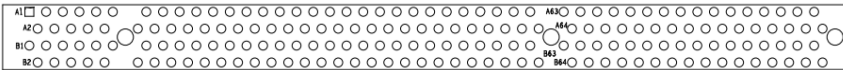

Pin #	Signal Description	Pin #	Signal Description	Pin #	Signal Description	Pin #	Signal Description
A1	+12V	A2	+12V	B1	NC	B2	GND
A3	+12V	A4	+12V	B3	GND	B4	+12V
A5	+5V	A6	PCI_INTE#	B5	+5V	B6	+5V
A7	PCI_INTG#	A8	+5V	B7	PCI_INTF#	B8	PCI_INTH#
A9	PCI_CLKRUN#	A10	+5V	B9	NC	B10	PCIE_WAKE#
A11	PLT_RST#	A12		B11	NC	B12	
A13		A14	+3.3V	B13		B14	NC
A15	PCI_RESET#	A16	+5V	B15	GND	B16	PCICLK1_33M
A17	PCI_GNT#1	A18	GND	B17	GND	B18	PCI_REC#
A19	AB_PME#	A20	Address 30	B19	+5V	B20	Address 31
A21	+3.3V	A22	Address 28	B21	Address 29	B22	GND
A23	Address 26	A24	GND	B23	Address 27	B24	Address 25
A25	Address 24	A26	Address 25	B25	+3.3V	B26	CBE#3
A27	+3.3V	A28	Address 22	B27	Address 23	B28	GND
A29	Address 20	A30	GND	B29	Address 21	B30	Address 19
A31	Address 18	A32	Address 16	B31	+3.3V	B32	Address 17
A33	+3.3V	A34	PCI_FRAME#	B33	CBE#2	B34	GND

A35	GND	A36	PCL_TRDY#	B35	PCL_IRDY#	B36	+3.3V
A37	GND	A38	PCL_STOP#	B37	PCL_DEVSEL#	B38	GND
A39	+3.3V	A40	SMB_CLK	B39	PCL_LOCK#	B40	PCL_PERR#
A41	SMB_DATA	A42	GND	B41	+3.3V	B42	PCL_SERR#
A43	PCL_PAR	A44	Address 15	B43	+3.3V	B44	CBE#1
A45	+3.3V	A46	Address 13	B45	Address 14	B46	GND
A47	Address 11	A48	GND	B47	Address 12	B48	Address 10
A49	Address 9	A50	CLK_ PCIE_X4_100MP	B49	GND	B50	NC
A51	CLK_ PCIE_X4_100MN	A52	CBE#0	B51	NC	B52	Address 8
A53	+3.3V	A54	Address 6	B53	Address 7	B54	+3.3V
A55	Address 4	A56	GND	B55	Address 5	B56	Address 3
A57	Address 2	A58	Address 0	B57	GND	B58	Address 1
A59	+5V	A60	+5V	B59	+5V	B60	+5V
A61	+5V	A62	+5V	B61	+5V	B62	+5V
A63	PCIE_RXP1	A64	PCIE_RXN1	B63	PCIE_TXP1	B64	PCIE_TXN1
A65	PCIE_RXP2	A66	PCIE_RXN2	B65	PCIE_TXP2	B66	PCIE_TXN2
A67	PCIE_RXP3	A68	PCIE_RXN3	B67	PCIE_TXP3	B68	PCIE_TXN3
A69	PCIE_RXP4	A70	PCIE_RXN4	B69	PCIE_TXP4	B70	PCIE_TXN4
A71	NC	A72	NC	B71	NC	B72	NC
A93		A94		B93		B94	

J20 – Battery Socket

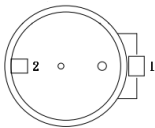

Pin # Signal Description

1	+3V
2	GND

J21 –TPM / ID-394

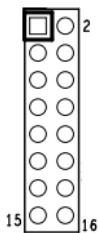

Pin #	Signal Description	Pin #	Signal Description
1	LPC AD0	2	PCI reset
3	LPC AD1	4	SERIRQ
5	LPC AD2	6	+3.3V
7	LPC AD3	8	+5V
9	LPC Frame	10	PCI CLKRUN
11	Debug CLK	12	SMB CLK
13	GND	14	SMB DATA
15	LPC PD	16	+3.3V

J22 –GPIO Interface(internal)

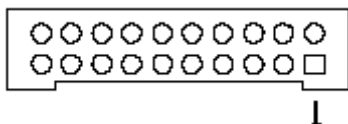

Pin #	Signal Description	Pin #	Signal Description
1	GPO 1	2	GPI 1
3	GPO 2	4	GPI 2
5	GPO 3	6	GPI 3
7	GPO 4	8	GPI 4
9	GPO 5	10	GPI 5
11	GPO 6	12	GPI 6
13	GPO 7	14	GPI 7
15	GPO 8	16	GPI 8
17	+5V	18	+5V
19	Ground	20	Ground

J23 – Lock LED / Outdoor LED Indicator

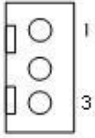

Pin #	Signal Description
1	+3.3V
2	Heater LED
3	Key Lock LED

J24,J25 – DDR3 SO-DIMM Interface

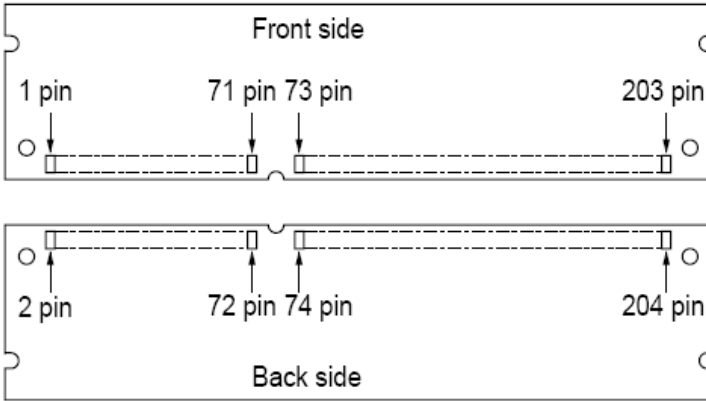

J26 – Light Sensor Connector



Pin #	Signal Description
1	Light Sensor
2	NC
3	+3.3V

J27 – Front Bezel Button Connector

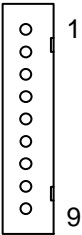

Pin #	Signal Description
1	Power Button
2	+3.3V
3	Sound Volume Up
4	Sound Volume Down
5	Ground
6	LCD BackLight Up
7	LCD BackLight Down
8	Touch Screen Forbid
9	LCD BackLight ON/OFF

J29 – LED

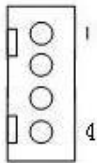

Pin #	Signal Description
1	SATA LED
2	+5V
3	+5V
4	Power LED

J30 – Motion Detection

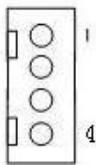

Pin #	Signal Description
1	Ground
2	Motion Detection
3	+5V
4	+3.3V

J31 – PS2 KB/MS connector

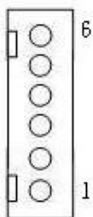

Pin #	Signal Description
1	Keyboard data
2	Mouse data
3	GND
4	5V
5	Keyboard clock
6	Mouse clock

J32, J35 – Passive Speaker Connector



1

J32(Right Channel)		J35(Left Channel)	
Pin #	Signal Description	Pin #	Signal Description
1	AMP. Out +	1	AMP. Out +

2	AMP. Out -	2	AMP Out -
---	------------	---	-----------

J33 – Internal MIC

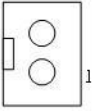

Pin #	Signal Description
1	MIC right
2	GND

J35,J47 – Handset Cable Link

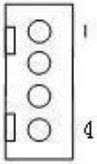

Pin #	Signal Description
1	AMP Shutdown
2	Handset speaker
3	Handset MIC
4	GND

J36 – ATX 12V for Heater1

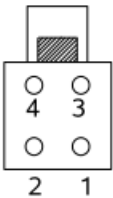

Pin #	Signal Description
1	Ground
2	Ground
3	+12V
4	+12V

J37,J38,J39 – COM4, COM5, COM6 Serial Port

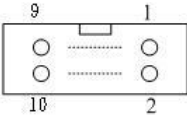

Pin #	Signal Description	Pin #	Signal Description
1	232_DCD	2	232_DSR
3	232_SIN	4	232_RTS
5	232_SOUT	6	232_CTS
7	232_DTR	8	232_RI
9	GND	10	+5VS

J40 – Ethernet Port

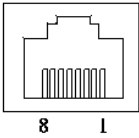

Pin #	Signal Description
1	Data0+
2	Data0-
3	Data1+
4	Data2+
5	Data2-
6	Data1-
7	Data3+
8	Data3-

J41 – Power Switch

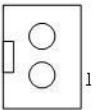

Pin #	Signal Description
1	Power ON
2	GND

J44 – Handset Connector

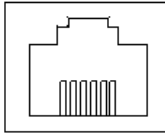

6 1

Pin #	Signal Description
-------	--------------------

1	AMP Shutdown
2	Handset speaker
3	Handset MIC
4	GND

J45, J46 – Audio Connector

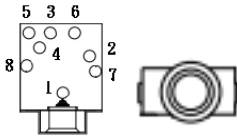

J45 - Microphone (stereo) Pink	
Pin #	Signal Description

1	GND
2	MIC left
3	MIC right
4	GND
5	MIC Detect
6	NC
7	GND
8	GND

J46 - Line Out (stereo) Green	
Pin #	Signal Description

1	GND
2	Headphone left
3	Headphone right
4	GND
5	Headphone Detect
6	HP/LINE#
7	GND
8	GND

J48 – Reset Button

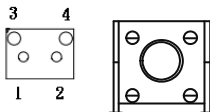

Pin #	Signal Description
-------	--------------------

1	System Reset
2	GND
3	GND
4	GND

J49 – Display Interface

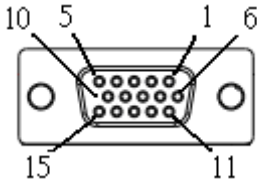

Pin #	Signal Description
1	RED
2	Green
3	Blue
4	N.C.
5	GND
6	GND
7	GND
8	GND
9	CRT +5VS
10	GND
11	N.C.
12	DDCDAT
13	HSYNC
14	VSYNC
15	DDCCLK

J50 – COM1 Connector

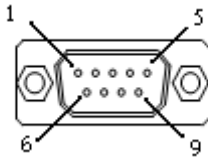

Pin #	Signal Description		
	RS-232	RS-422	RS-485
1	Carrier Detect	Transmit Data -	Transmit Data -
2	Receive Data	Transmit Data +	Transmit Data +
3	Transmit Data	Receive Data +	NC
4	Data Terminal Ready	Receive Data -	NC
5	Ground	NC	NC
6	Data Set Ready	NC	NC

7	Request to Send	NC	NC
8	Clear to Send	NC	NC
9	Ring Indicator	NC	NC

J51,J52 – COM2, COM3 Connector(COM4-J37)

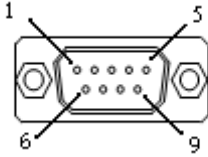

Pin #	Signal Description	Pin #	Signal Description
1	232_DCD	2	232_SIN
3	232_SOUT	4	232_DTR
5	GND	6	232_DSR
7	232_RTS	8	232_CTS
9	232_RI	10	Not Used

J54,J55,J56 – USB Port

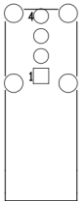

Pin #	Signal Description
1	+5V
2	USB_D-
3	USB_D+
4	GND

B. Wake UP on LAN Function

Please make sure the AC power is ON before use the function.

1. Boot into OS (windows XP).
2. In start menu control panel System device manager Network adapters double click Marvell Yukon 88E8071 Advance Wake from Shutdown Item select Wake on Magic packet from power off state.

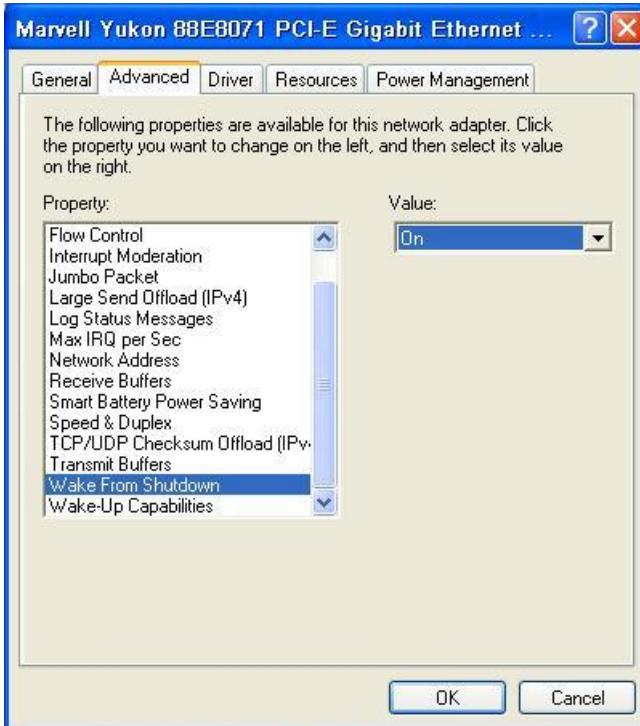

Please shutdown system and wait for wake on LAN after finish these procedures.